



VETERINARY

Mobile Dental Delivery System



Redesigned for greater efficiency at the point-of-care

Oral health care is important for your patients—and your practice. The next generation Midmark Mobile Dental Delivery System helps **improve the way you work by streamlining your dental workflow.**

















As awarded by the Chicago Athenaeum: Museum of Architecture and Design



WHAT'S INCLUDED

- High-Speed LED Handpiece (swivel available)
- Low-Speed Handpiece
- LED Piezo Scaler
- Three-way Air-Water Syringe
- Bur Block
- Sample Pack of Burs
- Handpiece Conditioning Spray
- Disposable Prophylaxis Angles
- Quick-Connect/Disconnect Water Bottles
- VistaTab™ Dental Waterline Cleaner Tablets (US only)
- Scaler Accessories
 - Autoclavable Storage Box
 - Scaler Tip Wear Guide
 - Tips (1S, 2, 10P)
 - Tip Wrenches

SYSTEM HIGHLIGHTS

-  Compact Design
-  Convenient Storage
-  Large Work Surface
-  Integrated Handles
-  User-friendly Controls
-  Cord Management
-  Smooth Handpiece Tubing
-  LED Water Level Indicator
-  Quick-Connect/Disconnect Water Bottle System
-  Easy Access Points for Serviceability
-  Onboard Maintenance Checklist
-  High-Speed LED Handpiece and LED Scaler Standard
-  Optional Dual High-Speed Handpieces
-  Optional Integrated Suction



01



02



03

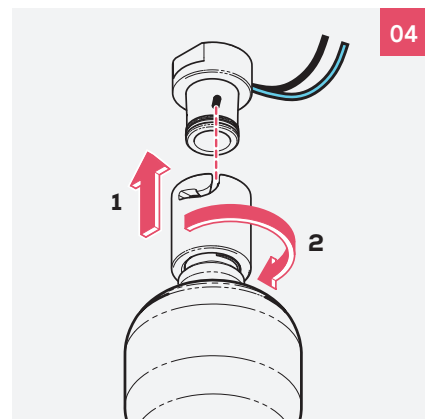

04

FLEXIBILITY + SAFETY

- Reduce hand and wrist fatigue with swivel handpieces designed to support proper ergonomics.
- Enhance infection control with a fully-enclosed design that can be easily disinfected.
- Enclosed system with oil-less compressor.



05

05 Integrated front and rear handles enhance push/pull maneuverability.

06 Reduce trip hazards with foot pedal and power cord storage and handpiece tubing lengths that avoid interference.



06



07

07 Utilize improved access points for adjustments and serviceability.

08 Store the unit under standard-height countertops to maximize floor space when not in use.

09 Keep supplies close with a large tray surface and storage drawer.



08



09

WORKFLOW EFFICIENCY

- Control all handpieces with one integrated foot pedal. Handpieces are automatically activated when lifted from the holder.
- Illuminate hard-to-see spaces in the oral cavity with a high-speed LED handpiece and scaler.

- 01 Add an optional suction accessory that integrates onto the handpiece bar for better accessibility.
- 02 Adjust system settings with a user-friendly control panel featuring LED water level indicator and graphics that align with handpiece positions.
- 03 Ensure staff is familiar with necessary system care by using the onboard maintenance checklist.
- 04 Access water bottles on the back of the unit and remove/replace with the quick-connect/disconnect mechanism.



Designed, assembled and supported in the USA.



MIDMARK® MOBILE DENTAL DELIVERY SYSTEM SPECIFICATIONS

Overall Dimensions (D x W x H)	18.6" x 17.4" x 33.8" (47.24 cm x 44.19 cm x 85.85 cm)
Compressor	Oil-free 1/2 hp motor Working pressure: 70-100 psi Flow rate: 2.2 CFM at 70 psi Air reservoir: 1 gallon
Water Module	Two 1-liter reservoirs (toggled) Pressurized system: 30-40 psi
 Complies with IEC 60601-1	



MIDMARK ACADEMY DENTISTRY TRAINING

Our RACE®-approved courses are delivered in your hospital by Boarded Veterinary Dentists and Veterinary Technician Specialists in Dentistry and will teach you how to achieve the highest level of dentistry excellence to grow your practice and improve the health of your patients.

- VI-CPC** Cleaning, Probing and Charting Best Practices Lab (RACE 4 Hours)
- VI-CPC-ADD** Add-on Regional Nerve Block Training (RACE 2 Hours)
- VI-RAD** Dental Radiography Positioning Training (RACE 4 Hours)
- VI-RAD-ADD** Add-on Regional Nerve Block Training (RACE 2 Hours)
- VI-RADCP** Level 1 Technician Dentistry Training (RACE 8 Hours)

Clinical dentistry labs for the DVM are offered in-hospital and regionally. Contact midmark-academy@midmark.com for more information.

BEST-PRACTICE SUPPORT

- Enjoy peace of mind with a market-leading warranty: 5-year limited parts and 2-year service. (Excludes handpieces)
- Access 40+ hours of RACE®-approved training to support your team and improve confidence in dentistry.
- Leverage clinical and technical support through 1.800.MIDMARK.

MIDMARK MOBILE DENTAL DELIVERY SYSTEMS

- AH9000-001** 4-Position with High-Speed LED Handpiece, Low-Speed Handpiece, LED Piezo Scaler and 3-Way Air-Water Syringe, (USA only)
- AH9000-002** 4-Position with High-Speed LED Swivel Handpiece, Low-Speed Handpiece, LED Piezo Scaler and 3-Way Air-Water Syringe, (USA only)
- AH9000-003** 5-Position with Dual High-Speed LED Swivel Handpieces, Low-Speed Handpiece, LED Piezo Scaler and 3-Way Air-Water Syringe, (USA only)
- AH9000-005** 4-Position with High-Speed LED Handpiece, Low-Speed Handpiece, LED Piezo Scaler and 3-Way Air-Water Syringe, (Canada only)
- 9A697001** Dental Suction Accessory (In-clinic installation required)

EXTENDED WARRANTY PLAN

Midmark extended warranty plans are an extension of your product's base warranty. The warranty can be extended to provide up to an additional 3 years of service coverage.

MOBILE DENTAL DELIVERY PERIODIC MAINTENANCE PLAN

Recommended annually to maximize your equipment uptime and prevent unexpected breakdowns.

For inquires on Extended Warranty and Periodic Maintenance Plans email: serviceproducts@midmark.com



For a complete listing of Midmark Academy Dentistry and Anesthesia courses, visit midmarkacademy.com.



Additional dental delivery accessories are available at midmarkserviceparts.com.



Designing better care.®

VistaTab, TÜVRheinland and RACE are not trademarks of Corporation and are the sole property of respective owners.

Midmark is an ISO 13485 and ISO 9001 Certified Company. Certain products are not included. See the complete list at: midmark.com/ISO

For more information, contact your Midmark dealer or call: 1.800.MIDMARK. Outside the USA call: 1.937.526.3662 or visit our website: midmark.com

© 2025 Midmark Corporation, Versailles, Ohio USA.
Products subject to improvement changes without notice.

007-10160-00 Rev D1 (2/25)

